

## Operating instructions

Order No.	Rated voltage	Power consumption
7LF4 101	~ 220...240 V	5 VA
7LF4 102	~ 24V = 24 V	1 VA
7LF4 103	~ 12 V	1 VA

WA-EKF 2259/1.93/S; Mo/D: Ko/80.10.0619.7

### 1.0 Foreword

Read the operating instructions carefully to ensure optimum utilization of all functions. The operating concept of this microprocessor-controlled time switch has been designed according to up-to-date didactic experience. Programming is logical and easy to understand. It can be used as a daily or weekly time switch.

#### 1.1

The switching commands can be entered independent of one another for the following applications:

- for the standard program
- for the random program
- for the holiday program (🏠)

b) and c) can be combined

#### 1.2

If the "prog" button is pressed briefly before programming has been completed, the missing elements will start flashing – as a check. The partial entry is then erased after approx. 20 seconds, refer to 5.b.

#### 1.3

Every time the program is altered, the time (e.g. switching from summer to winter time), holiday program or random program, the time switch always adopts the switching condition dictated by the current program.

### 2.0 Connection

Electrical devices should only be installed and assembled by qualified electricians. The term "electricians" is defined in VDE 0105.

Electrical devices are protected against external interference to a great extent in accordance with modern knowledge.

Countermeasures can be taken in the event of a fault – e.g. voltage peaks – by fitting standard components (varistors, suppressor diodes, etc.). Be particularly careful when the time switch is used to control inductive loads.

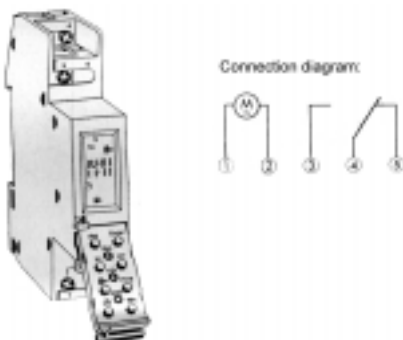

### 3.0 LCD unit

total display content:

Example a)  
current time and day of the week  
channel status e.g. ON

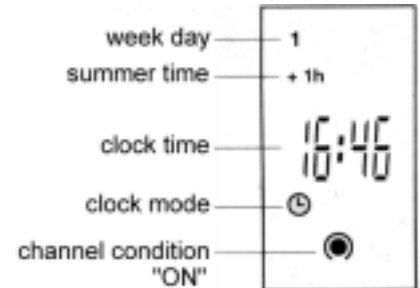
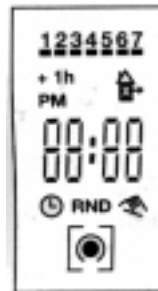

Example b)

- holiday program, random check generator
- channel status e.g. OFF

Example c)

- switching preselection / manual switch
- channel status e.g. manual ON



channel condition "OFF"

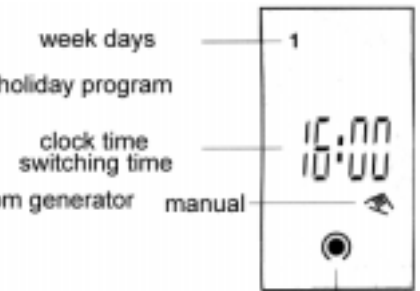

channel condition "ON"

### 4.0 Keyboard specifications – commissioning - programming

#### 4.1 Commissioning

- "Res" → a) before each restart  
→ b) to erase all stored information and the current time on the display and in the memory

Press the "Res" key – the following display appears after approx. 3 seconds:

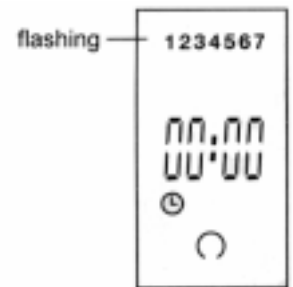
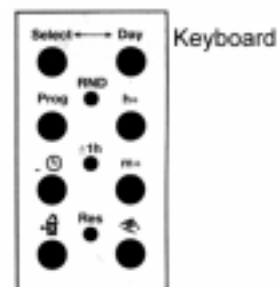

#### 4.2 Programming the current day of the week, the time, and setting the summer or winter time (normal time)

⌚ + Day = week day (1 = monday)

**Note:**

Figures 1 ...7 start flashing if no day is selected

⌚ + h+ = time (hours)

⌚ + m+ = time (minutes)

**Note:**

Keep the ⌚ key pressed until Day, h+, and m+ have been entered.

a) Example

b) Example

(winter time / normal time)

(summer time) ⌚ + ± 1h

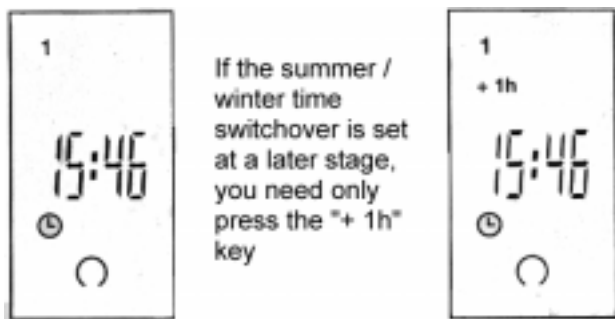

- a) to stipulate the switching function ● = ON, or ○ = OFF, when programming switching times (standard, random, holiday program) Refer to 4.4, 6.0, 7.0, 7.1
- b) to change the relay contact in the standard program manually, ● = ON or ○ = OFF

**Switching preselection:** This manual function will be cancelled with the next switch command. The next program step will be activated automatically.

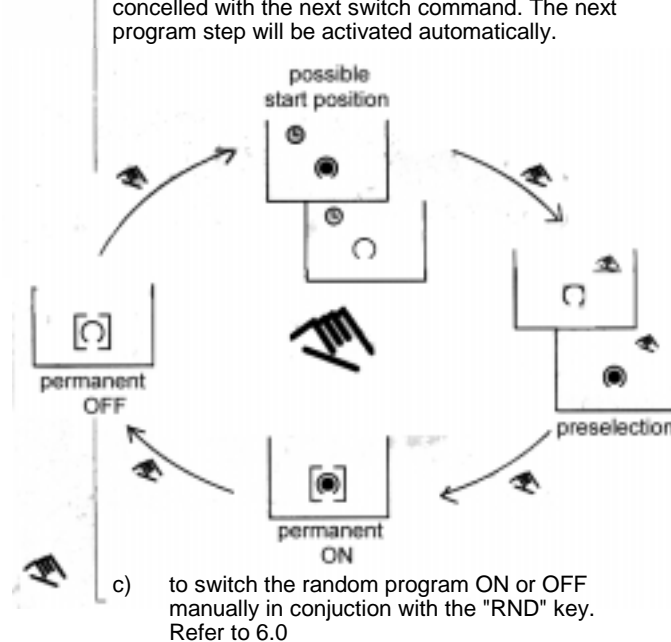

- c) to switch the random program ON or OFF manually in conjunction with the "RND" key. Refer to 6.0

#### 4.3

The relevant keys are always pressed individually for all other programming functions or when interrogating (reading) stored data.

- a) Select memory location 1 to enter the required switching times and functions.  
**Note:** Are switching times entered yet, hold the key "prog" pressed (roll mode). It stops at the 1<sup>st</sup> free storage place — : —. If after — : — key "Prog" is pressed again, the display shows the number of free storage places f.o. 35.

8888 = all storage places occupied.

Durring indication f.e. Fr:35 a program can be entered directly with Day, h+, m+, ⌚, ⌚

- "Prog"**
- b) Saves the programmed data and selects the next free memory location..  
**Note:** If the "Prog" key is not pressed, the system switches to the current time after approx. 2 min, saving the switching command.

selects the weekday(s)

- "Day"**
- a) for switching commands (standard, RND, ⌚)
  - b) to start the holiday programm (day of the week)

- "Select"**
- a) to select (yes/no) the weekday(s) for switching command (standard, RND, ⌚)
  - b) duration of the holiday program (max. 99 days)

#### 4.4 Switching commands for the "standard weekly program"

a) Days of the week

Example: 1 2 4 5 (Mo, Tu Th, Fr)

Keys: Prog.

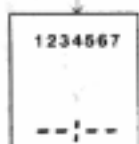

Day, Select

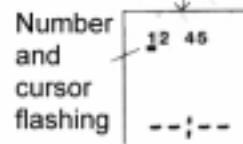

- if 1 (Monday) OK, select other days of the week with "Day".
- if 1 (Monday) not required, select days of the week with "Select".

**Note:**

If you make a mistake, use the "Select" key to reselect the day in question, then next day of the week 2 (Tuesday) with "Day", etc..

- b) Switching time and status  
 If the h+ or m+ key is held down for longer than 2 seconds, the system enters "fast forward" mode (scrolling)

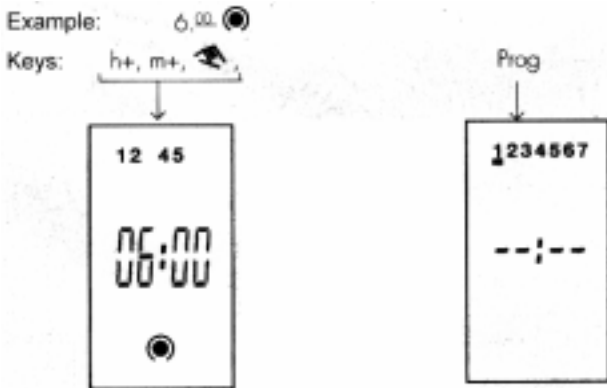



### 5.0 Editing and deleting switching commands





- a) Editing switching commands  
 Select the switching commands in question with the "Prog" key – reading, then after the stored data – overwriting.  
 Save again by pressing the "Prog" key.
- b) Deleting switching commands  
 Select the switching commands in question with the "Prog" key – reading, then set the hours and minutes to — . Press the "Prog" key again and keep it pressed for approx. 3 seconds to delete the switching command.
- c) The other stored switching commands are advanced automatically so that there are no "empty lines".

### Special function

#### 6.0 RND = random program / random check generator

- a) without any assigned switching times  
 The random program can be switched  = ON or  = OFF manually at any time.



The "random" switching times are within the following fixed values:

-  max. 60 minutes
  -  max. 30 minutes
- } min. 5 minutes
- RND +  = switch on the random program
- 5 x  = switches of the random program and returns to automatic mode – refer to 6.0 b

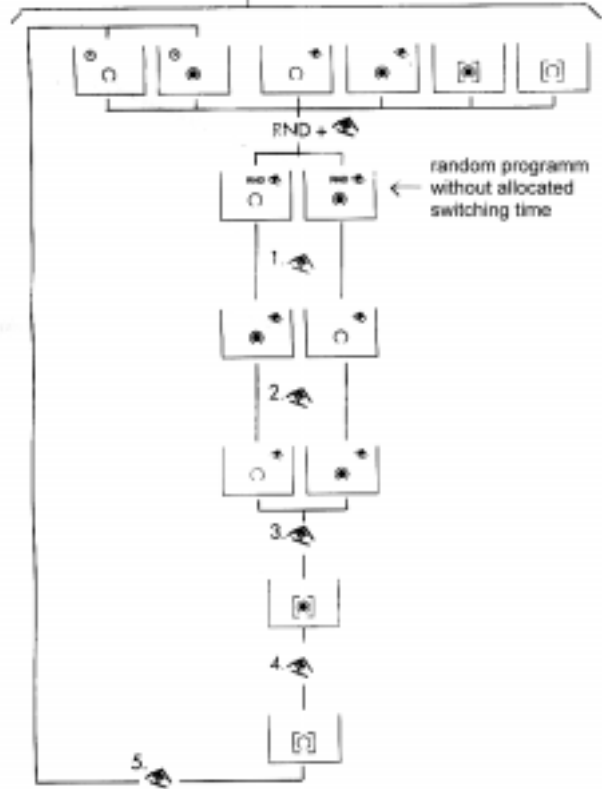



possible starting positions (without assigned switching times)

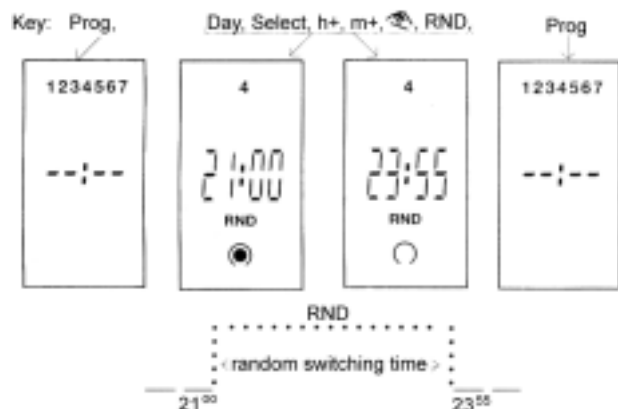

- b) with assigned switching times  
 Switching times, which are assigned to the "RND" index, determine the start and finish of the random program.  
 The "random" switching times are within the fixed values specified under 6.0 a.  
 The connected loads (e.g. staircase lighting) are switched on and off at irregular (random) intervals.

Example: 4 (Th) 21<sup>00</sup>  RND  
 4 (Th) 23<sup>55</sup>  RND



**Note:** The switching  of the relay may be  or  after "RND ". It may be advisable to program an additional "Standard" command.

- c) The random program can, of course, be interrupted or advanced at any time.

possible starting positions with assigned switching times

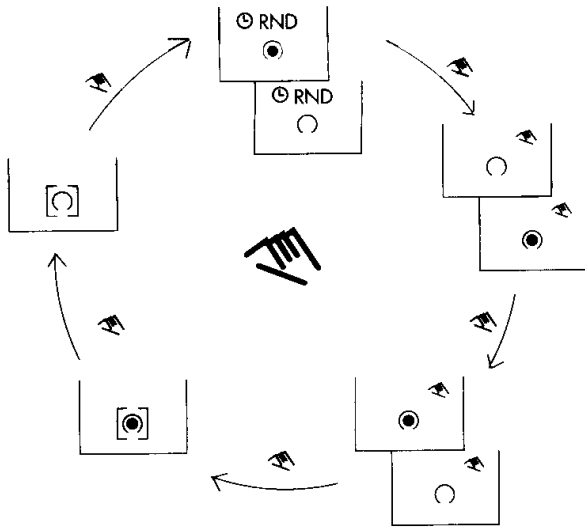

## 7.0 = holiday program

- The holiday program has priority over the "standard weekly program", refer to 4.4.
- The symbol can only be assigned to switching times which have been selected for all 7 days of the week.
- The holiday program is only activated if:
  - switching times have been stored in the way described under 7.1
  - the duration of the holiday has been preselected (1...99 days)
  - or has been specified without a time limit.
- The start of the holiday program can be the current day of the week, or can be preset up to 6 days in advance.

## 7.1

Switching times for the holiday program are entered in the same way as "normal" switching commands, refer to 4.4, but the symbol must also be entered for each switching time in the holiday program.

Example: 1 2 3 4 5 6 7 (Mo ... Su) 16<sup>00</sup>   
 1 2 3 4 5 6 7 (Mo ... Su) 23<sup>00</sup>

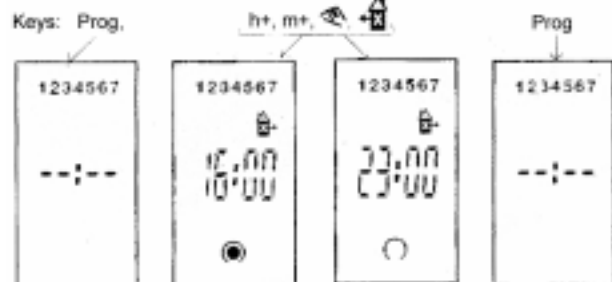

## 7.2 Commencement and duration of the holiday program

Important: The key must be pressed to return the time switch to the current operating state before programming the commencement and duration of the holiday program.

If no switching times have been programmed for the holiday program, the holiday symbol starts flashing when the button is pressed. Refer to 7.1 for information on programming switching times for the holiday program. Press once, the following display appears: The cursor for the current day of the week starts flashing.

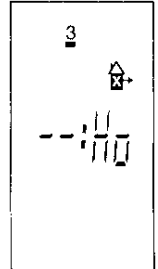

If you press the key at this point, the holiday program (Ho = holiday) is set for an unspecified period (refer to 6.0 c).

- If the holiday program is to start on day 3 (Wednesday), as in our example, enter the duration of the holiday in days with the "Select" key.

Example

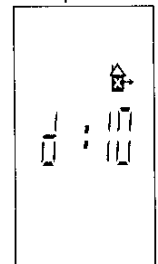

If the "Select" is held down for longer than 2 seconds, the "fast forward" mode is activated (scrolling), e.g. 10 days.

Example

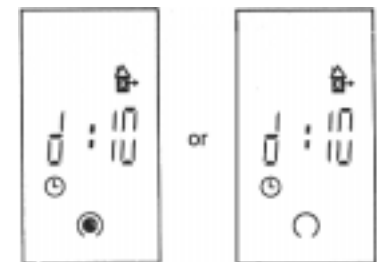

- Pressing the key stores the programmed information. At the same time, the current switching status is displayed in accordance with the holiday program.

- Note:** You can read the programmed information by pressing the key. Day of the week, time, switching status, etc.

Example

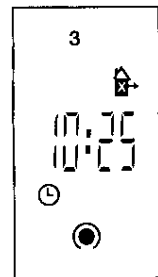

- The preselected duration of the holiday (10 days) is counted down from day to day - d 10, d 9, d 8, ... after which the current time reappears on the display. The switching times for the holiday program are retained, but are no longer active, refer to 7.0 c.

- If you wish the holiday program to start at a later date (up to 6 days, in advance), use the "Day" key to select the required day of the week (e.g. 1), then enter the duration of the holiday with the "Select" key, refer to 7.2 a.

Example

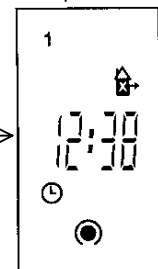

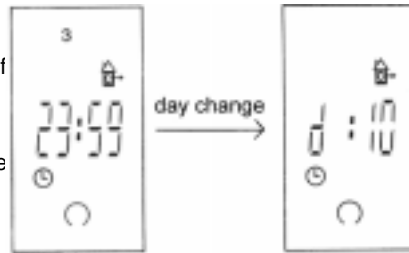

At the display appears: Pressing the key stores the programmed data and returns the time switch to its current switching status.

The current time is displayed up to the preprogrammed start of the holiday program. At midnight, when one day changes to the next, the duration of the holiday appears on the display.



### 7.3 Premature termination / interruption of the holiday program

- If the holiday program has already commenced, press the  key once. The time switch returns to its current switching status.
- If the holiday program has not yet started, press the  key twice. The preprogrammed duration of the holiday appears first on the display, followed by the current switching status.

### Technical Data

Power consumption	5 VA
AC switching capacity	
- resistive load (VDE, IEC)	16 A / 250 V AC
- inductive load cos. φ 0,6	2,5 A / 250 V AC
incandescent lamp load	1000 watt
DC switching capacity	
24 V DC / 60 V DC / 220 V	800 mA / 300 mA / 150 mA
Switching output	floating
Switching contacts	1 changeover contact (relay)
Ambient temperature	- 10 °C to +55 °C
Class of protection (VDE 0633)	II
Accuracy	typ. 2,5 s / day at + 20 °C
Running reserve	150 h to + 20 °C
Charging time (NC battery)	140 h
Shortest switching time	1 min.
Programmable	every minute
Memory locations	42
Holiday program	max. 99 days
Manual switch	automatic mode / switching preselection / FIX ON / FIX OFF
Block generation	free weekday and channel block generation
Summer- / winter time switchover	yes
Sealable	yes
Random-check generator	Programmable start / stop time and day

Subject to change without prior notice, when technically necessary.